

**ПК 01**

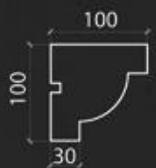

**ПК 02**

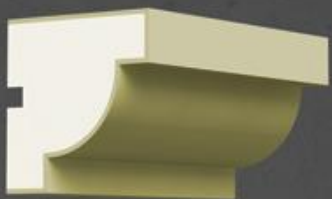
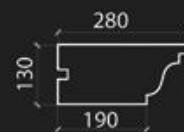

**ПК 03**

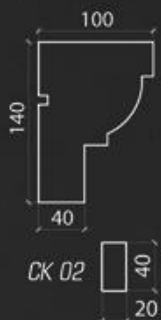

**ПК 04**

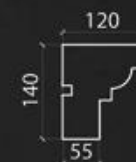

**ПК 05**



**ПК 06**



**ПК 07**

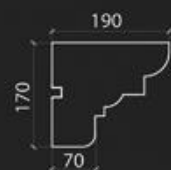
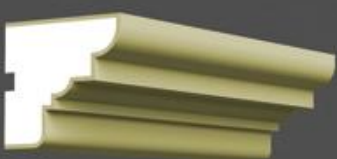

**ПК 08**

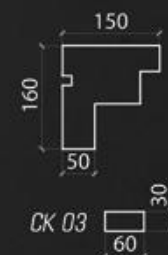

**ПК 09**

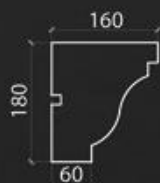

**ПК 10**





**ПК 11**

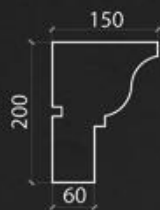
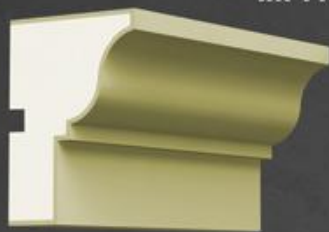

**ПК 12**



**ПК 13**



**ПК 14**

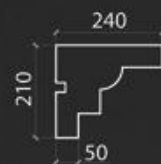

**ПК 15**

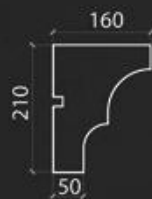

**ПК 16**

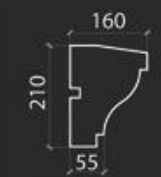

**МОДИФИКАЦИИ**



**ПК 27**

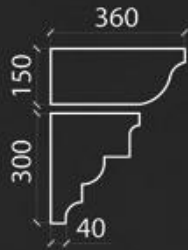

**ПК 31**

**ПК 17**



**ПК 18**

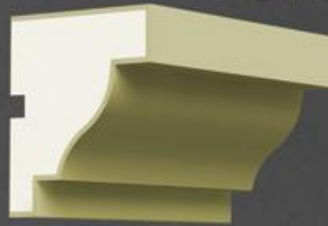

**ПК 19**

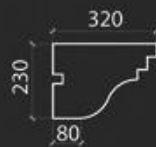

**ПК 20**

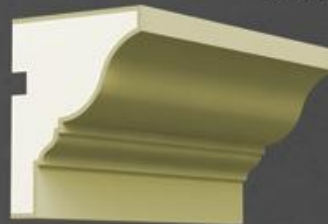

**ПК 21**



**ПК 22**

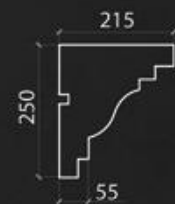

**ПК 23**

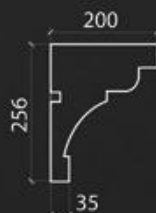
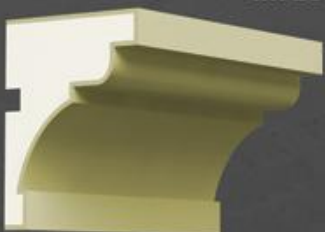

**ПК 24**

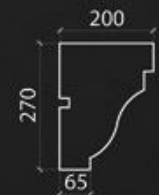
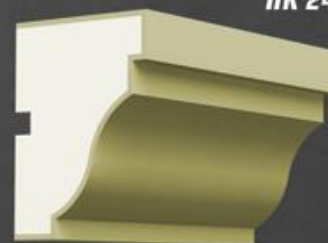

**Plast Decor**



**ПК 25**

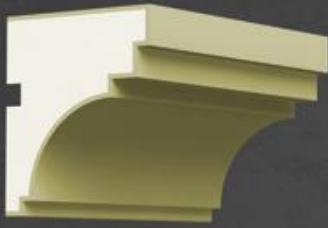

**ПК 26**



**ПК 27**

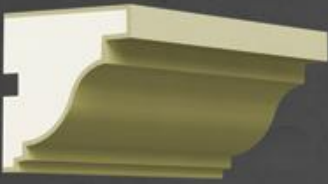

**ПК 28**

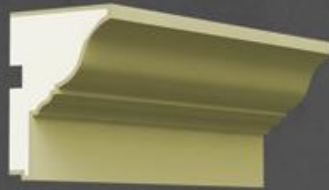

**ПК 29**

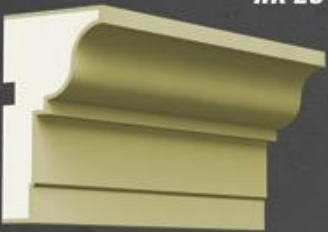

**ПК 30**

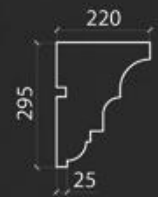
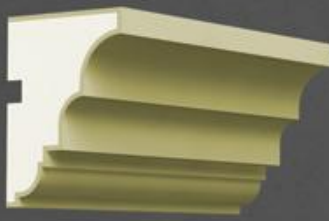

**МОЛДИНГИ**



**ПК 31**

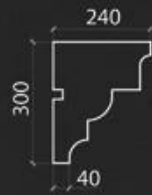

**ПК 32**

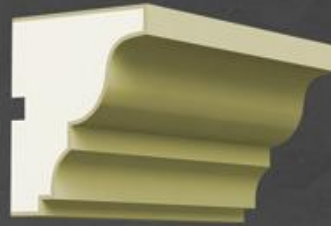

**ПК 33**

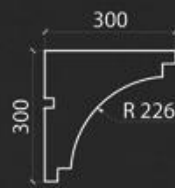
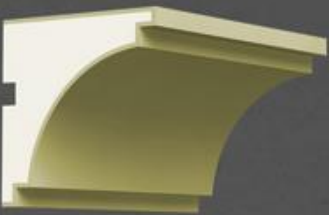

**ПК 34**

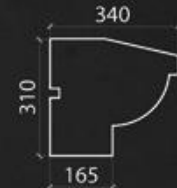

**ПК 35**



**ПК 36**

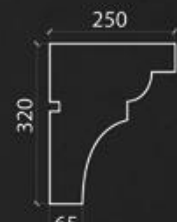

**ПК 37**



**ПК 38**

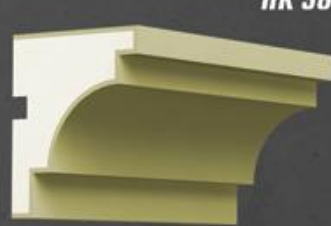

**ПК 39**

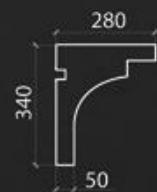

**ПК 40**

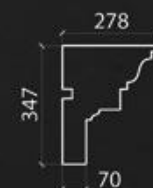

МОДУЛИ



**ПК 41**



**ПК 42**

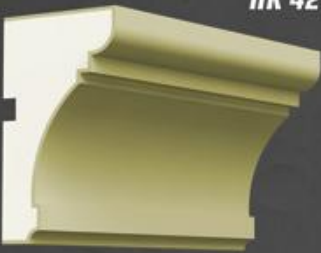

**ПК 43**



**ПК 44**



**ПК 45**

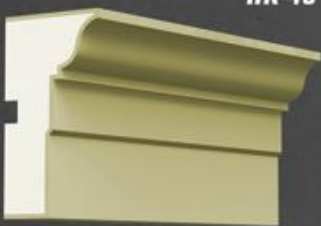

**ПК 46**



**ПК 47**



**ПК 48**

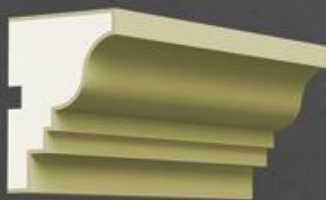

**МОЛДИНГИ**

ПК 49

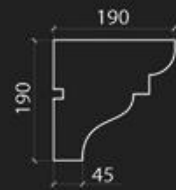
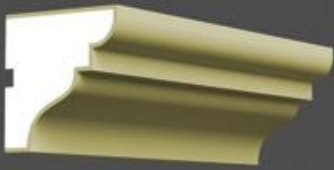

ПК 50

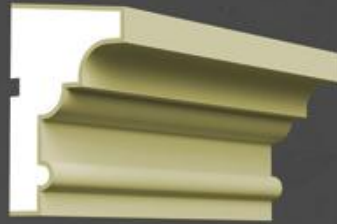

ПК 51



ПК 52



ПК 53

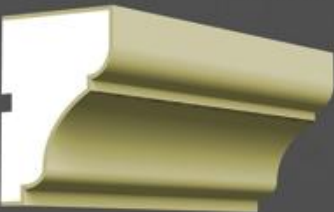

ПК 54

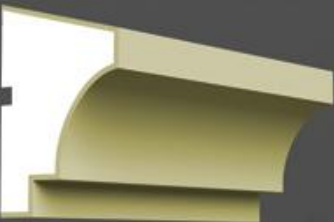

ПК 55

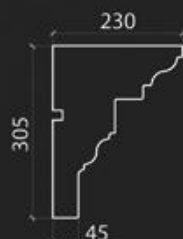

МОДУЛИ



**ПК 56**



**ПК 57**

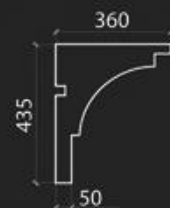
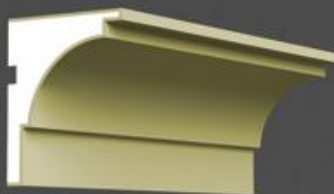

**ПК 58**



**ПК 59**

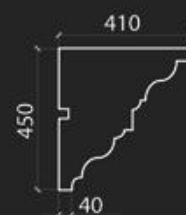

**ПК 60**



**ПК 61**

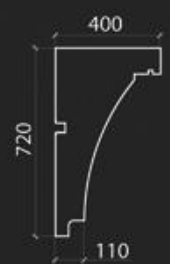

**МОЛДИНГИ**





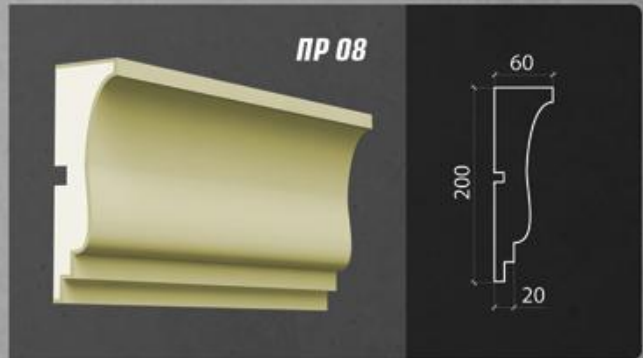
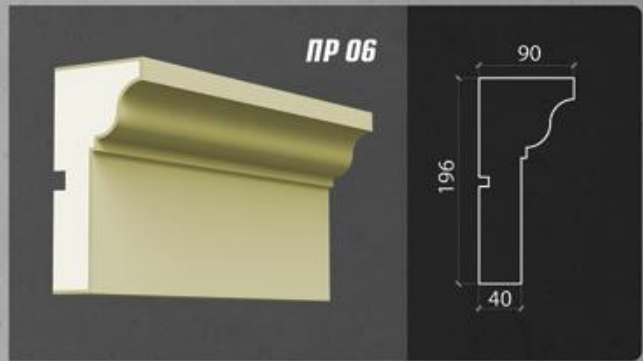
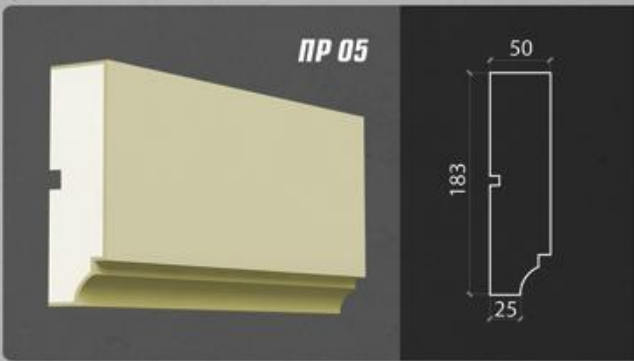
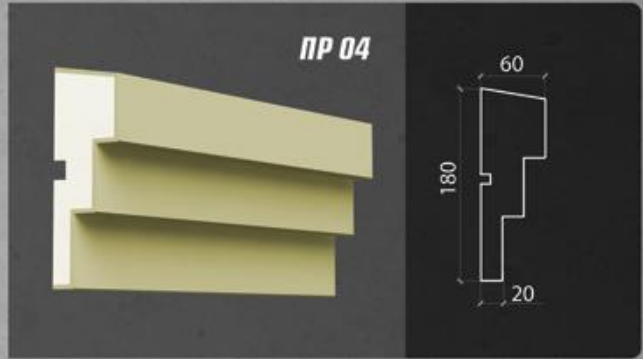
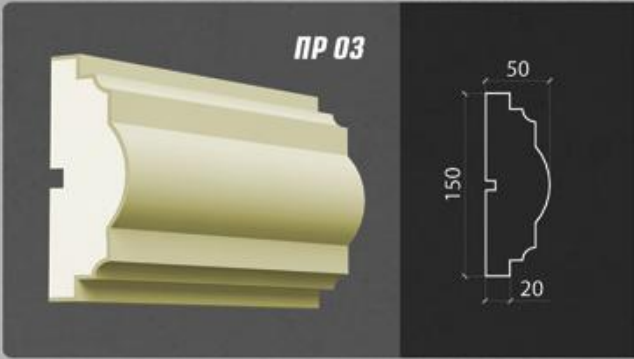
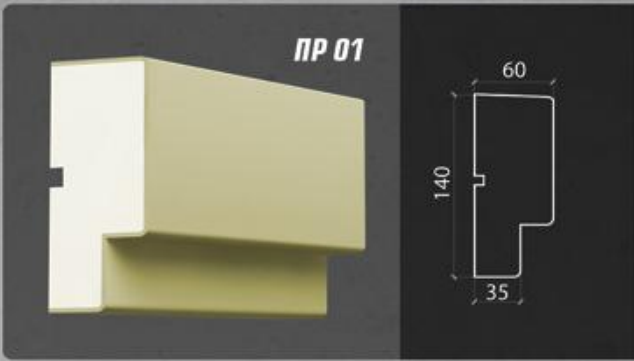

**МОДІЛІНГ**



**ПР 11**



**ПР 12**



**ПР 13**



**ПР 14**



**ПР 15**



**ПР 16**

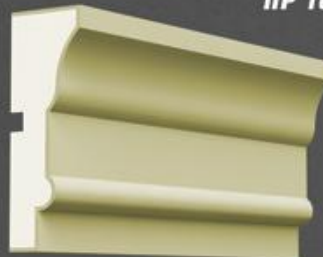

**МОЛДИНГИ**



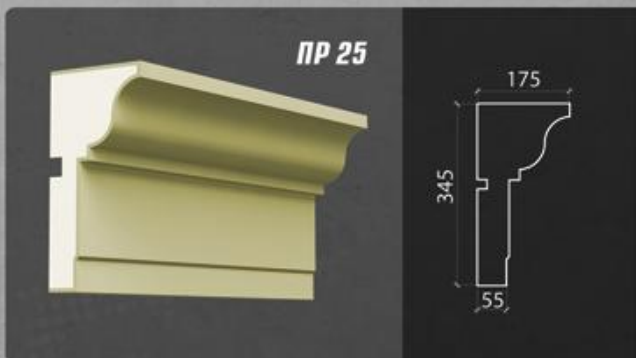
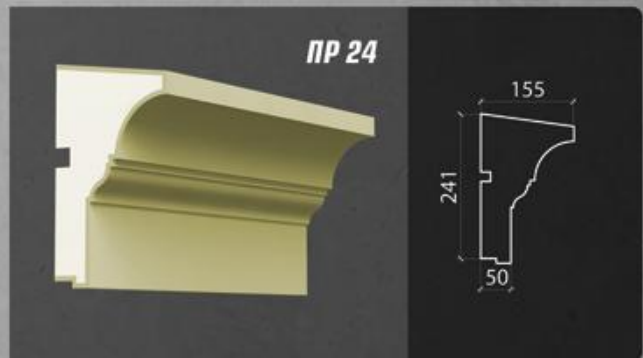
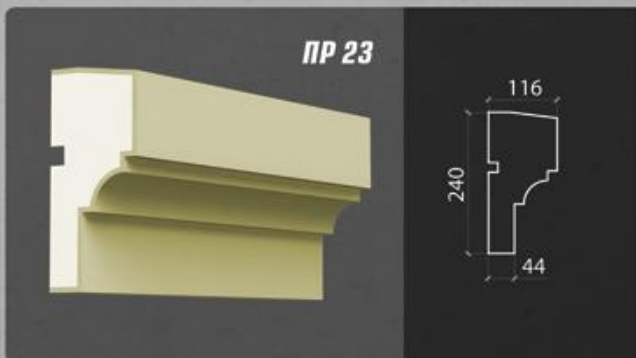
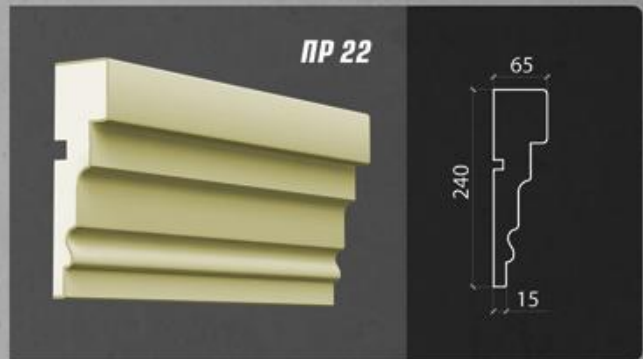
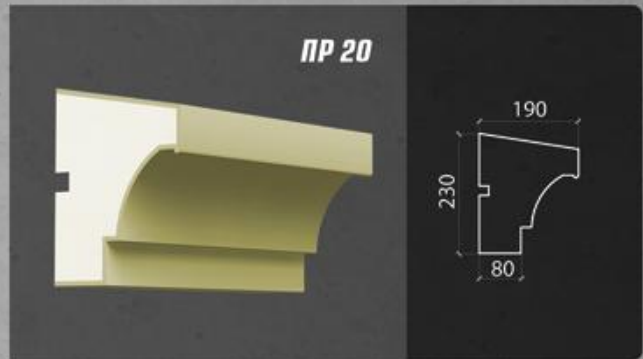
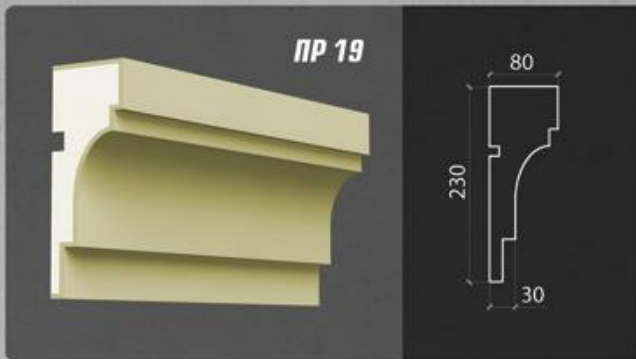
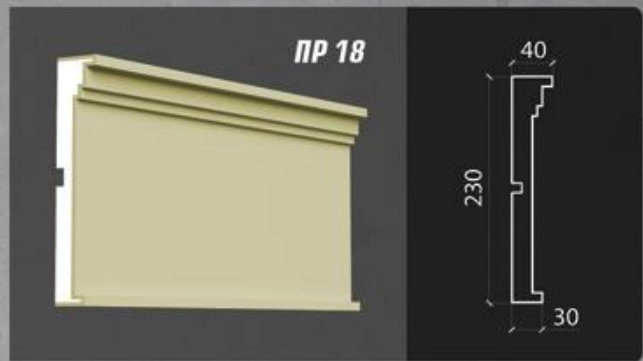

**МОДУЛИ**



**ПР 27**



**ПР 28**



**ПР 29**



**ПР 30**



**ПР 31**



**ПР 32**



**ПР 32**



**ПР 33**



**ПР 34**



**ПР 40**

ПР 35



ПР 36



ПР 37



ПР 38



ПР 39



ПР 40



ПР 41



ПР 42



ПР 43



ПР 44





ПР 45



ПР 46



ПР 47



ПР 48



ПР 49



ПР 50



ПР 51



ПР 52



МОЛДИНГИ

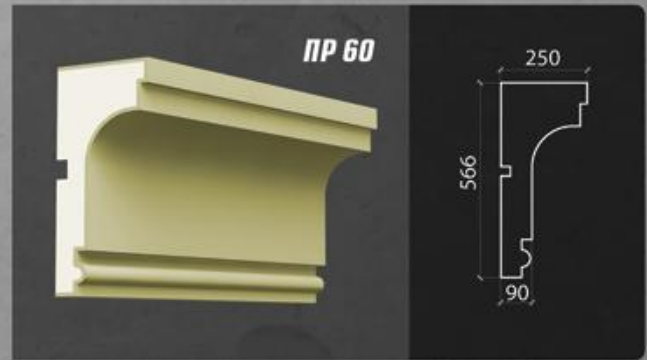
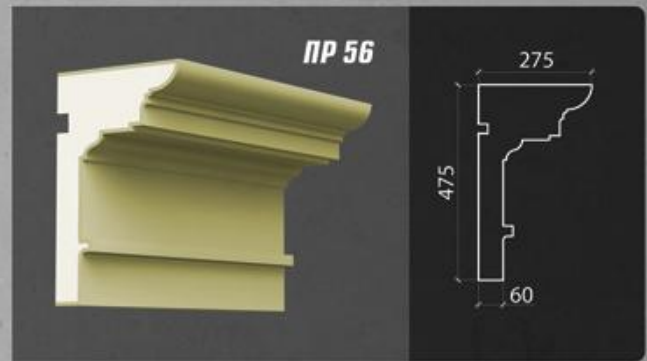
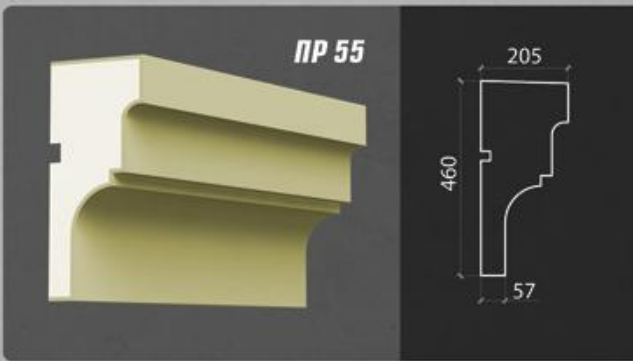
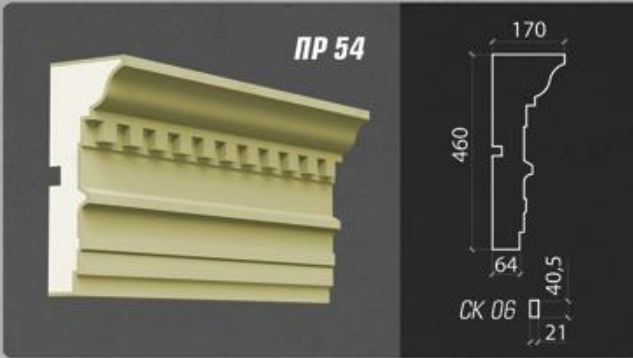

МОДУЛИ

**ПР 61**



**ПР 62**



**ПР 63**



**ПР 64**



**ПР 65**



**ПР 66**



**ПР 67**



**ПР 68**



**ПР 69**



**ПР 70**





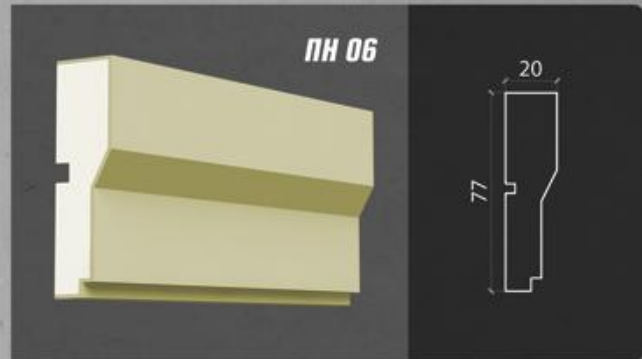
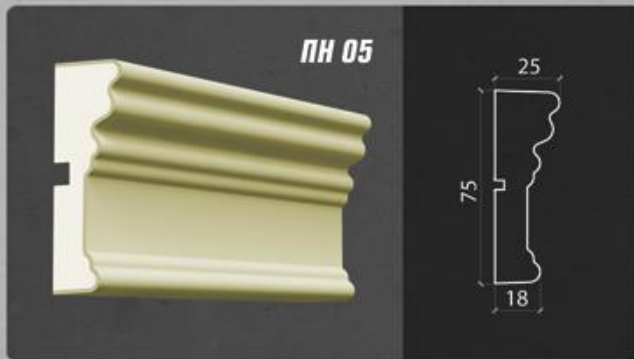
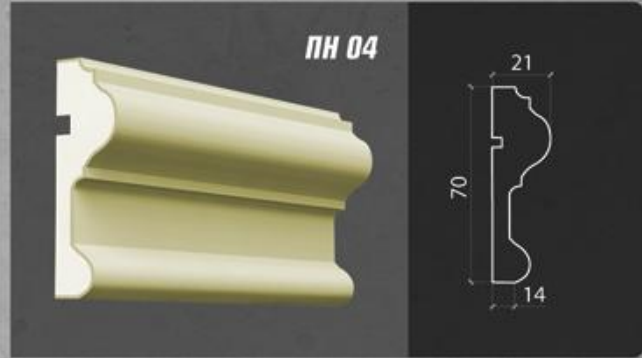
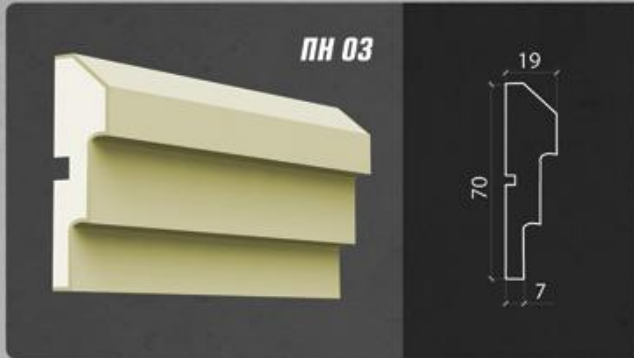
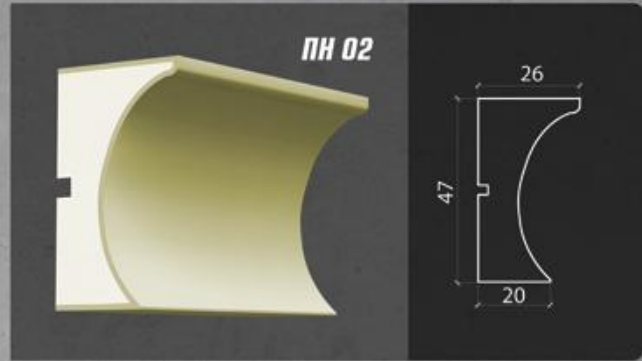
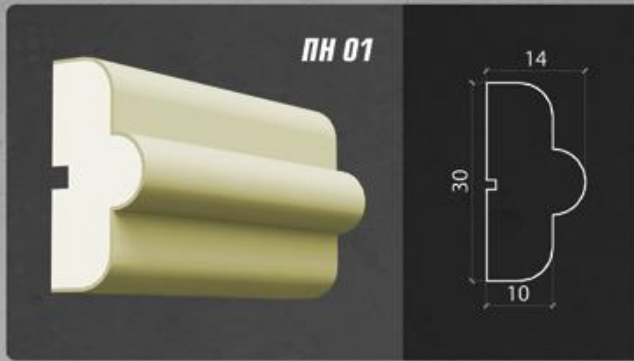

МОЛДИНГИ



**ПН 07**



**ПН 08**



**ПН 09**

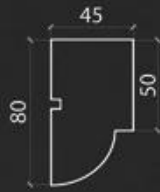
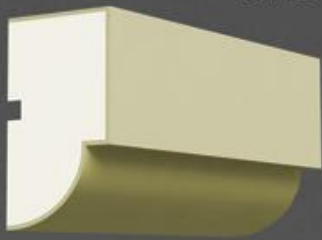

**ПН 10**



**ПН 11**

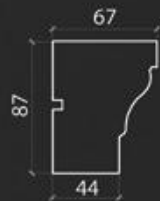

**ПН 12**

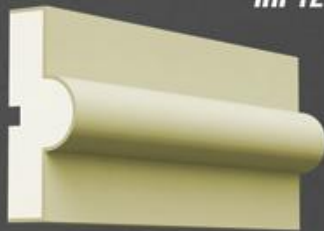

**ПК 19**

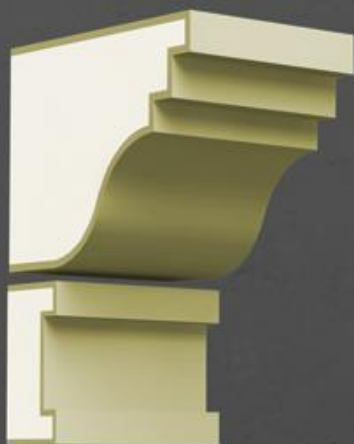

**ПН 38**

**ПН 13**



**ПН 14**





**ПН 15**



**ПН 16**



**ПН 17**



**ПН 18**

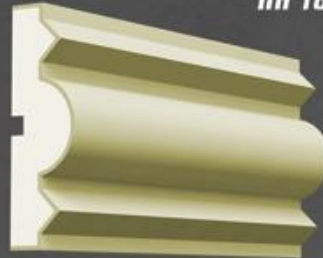

**ПН 19**



**ПН 20**

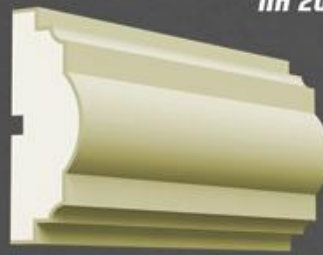

**ПН 21**



**ПН 22**

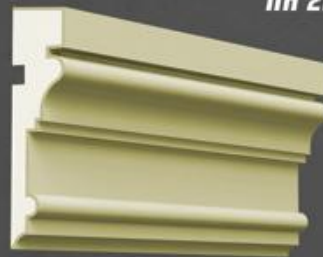

**ПН 23**



**ПН 24**





ПН 25



ПН 26

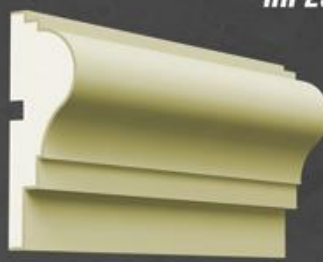

ПН 27



ПН 28



ПН 29



ПН 30



ПН 31



ПН 32



ПН 33



ПН 34



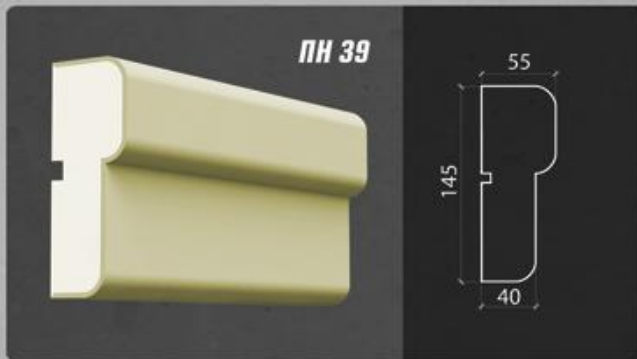
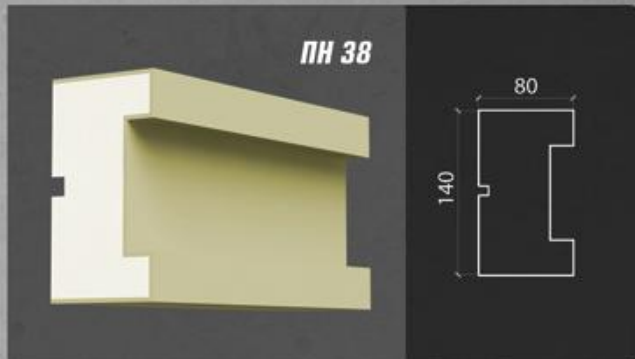
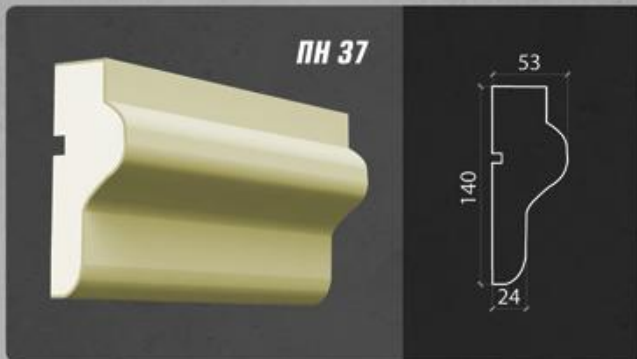
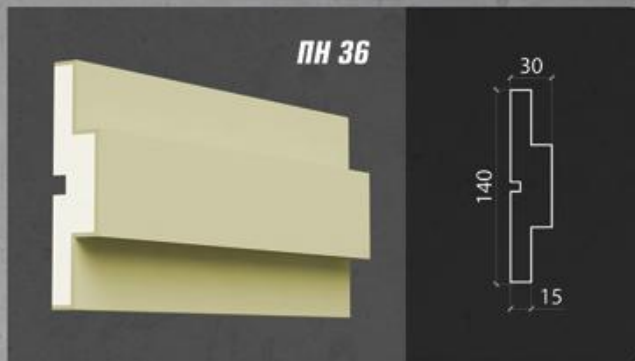

МОДИЛИ



ПН 42



ПН 43



ПН 44



ПН 45

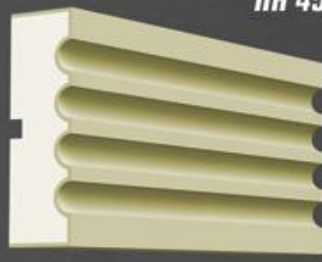

ПН 46

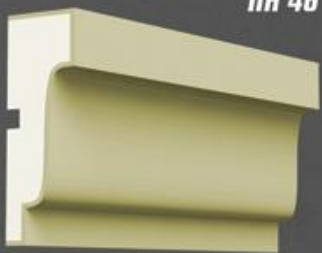

ПН 47



ПН 48



ПН 49



ПН 50



ПН 51

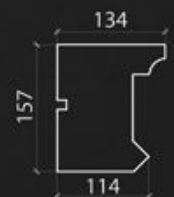
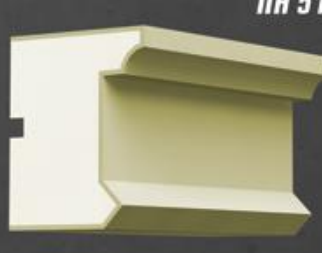

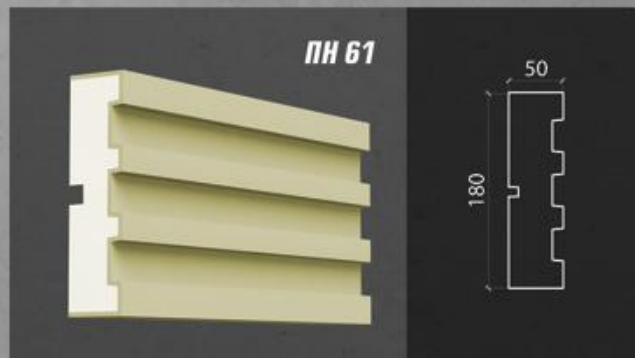
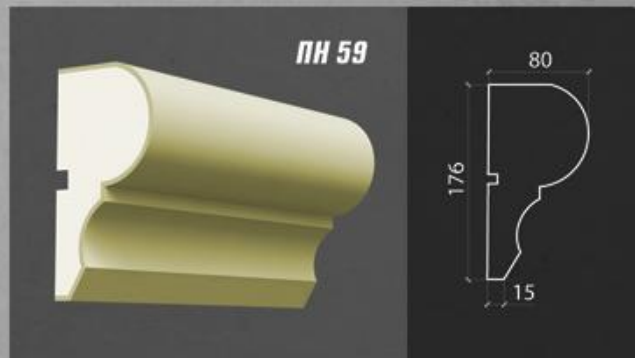
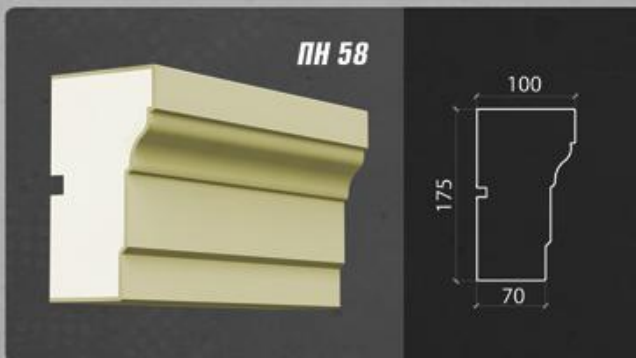
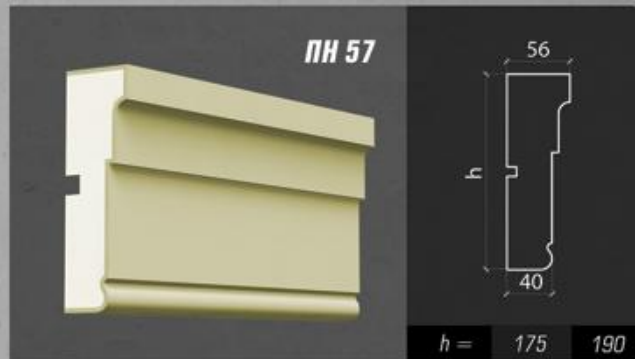
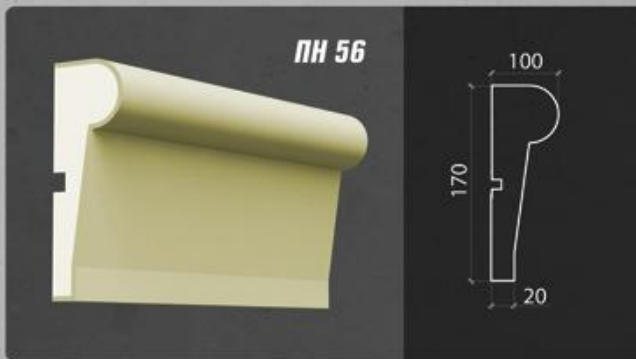
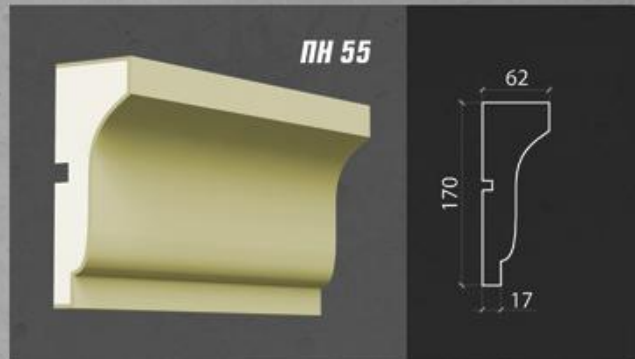
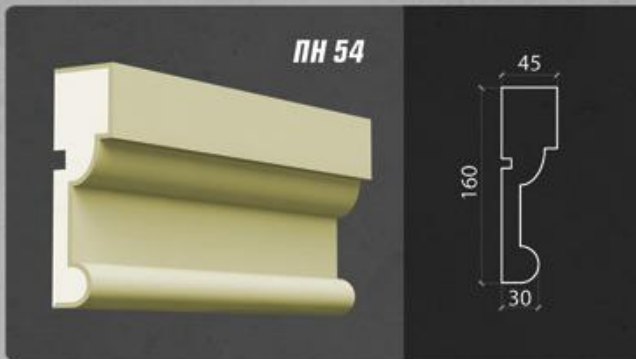
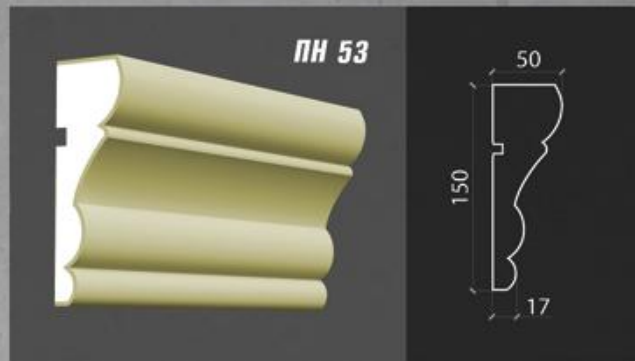
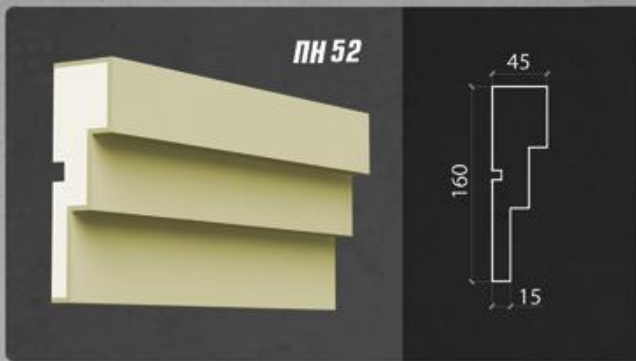

МОЛДИНГИ

**ПН 62**



**ПН 63**



**ПН 64**

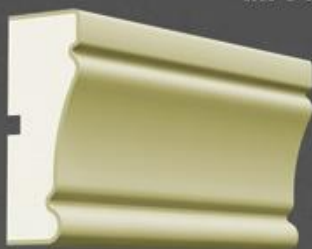

**ПН 65**



**ПН 66**

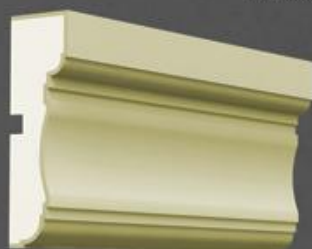

**ПН 67**



**ПН 68**



**ПН 69**



**ПН 70**



**ПН 71**





ПН 72



ПН 73



ПН 74



ПН 75



ПН 76



ПН 77



ПН 78



ПН 79



МОЛДИНГИ



nn 01



nn 02

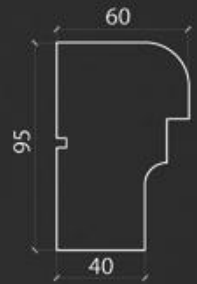

nn 03

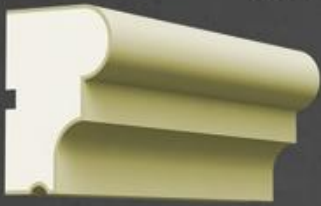

nn 04



nn 05



nn 06

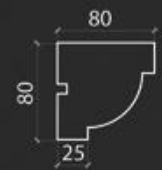
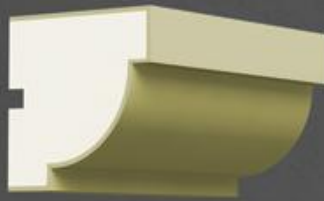

nn 07

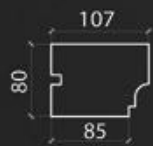

nn 08

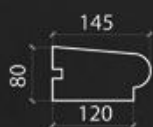

nn 09

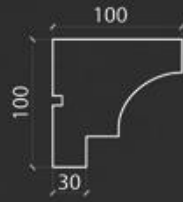
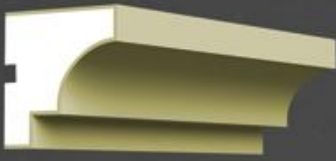

nn 10



nn 11

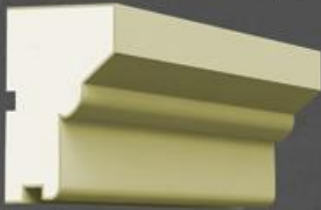

nn 12



nn 13



nn 14

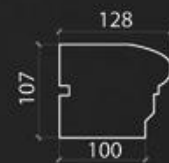

nn 15



nn 16

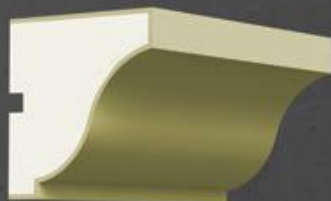

nn 17



nn 18





МОЛДИНГИ

ПП 19

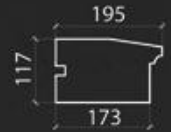

ПП 20

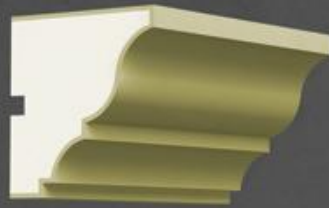

ПП 21

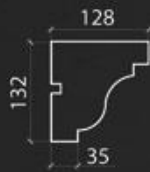
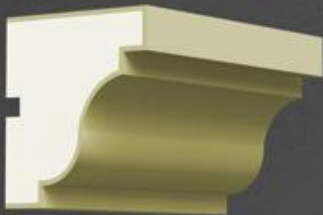

ПП 22

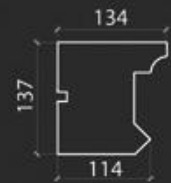

ПП 23



ПП 24



ПП 25

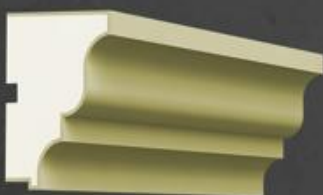

ПП 26

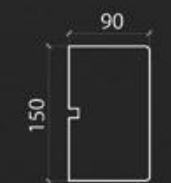
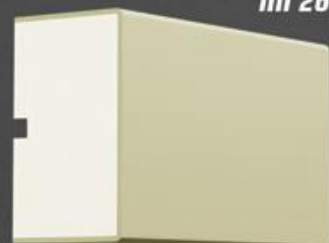



пн 27



пн 28

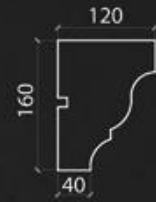
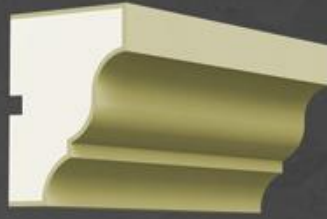

пн 29



пн 30



пн 31



пн 32



пн 33





**ПП 34**



**ПП 35**

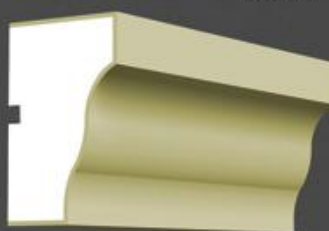

**ПП 36**

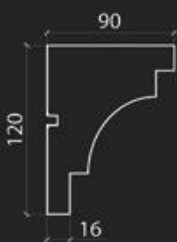

**ПП 37**

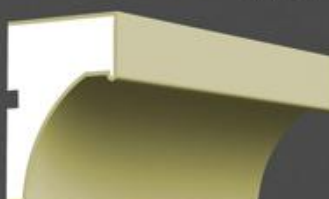

**ПП 38**

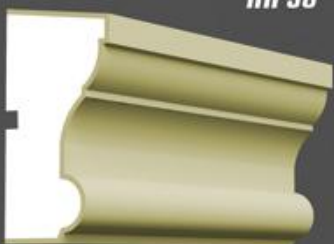

**ПП 39**

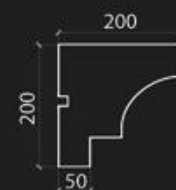
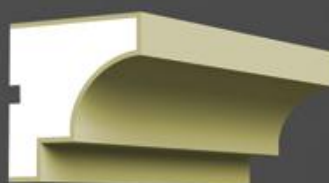

**ПП 40**

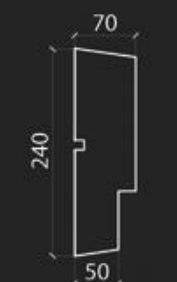

**ПП 41**



**ПП 42**

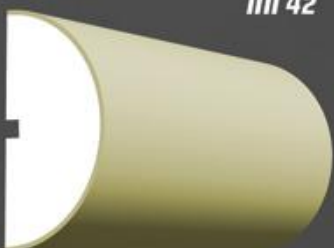

**ПП 43**



**МОЛДИНГИ**

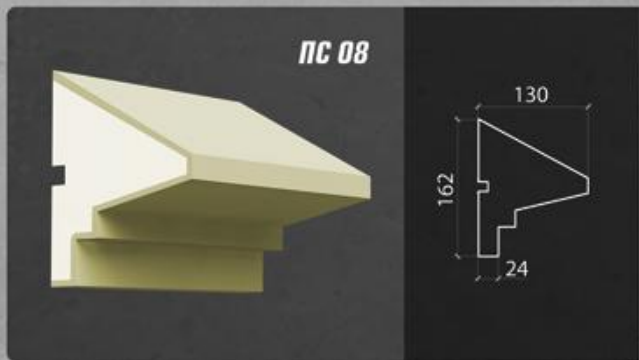
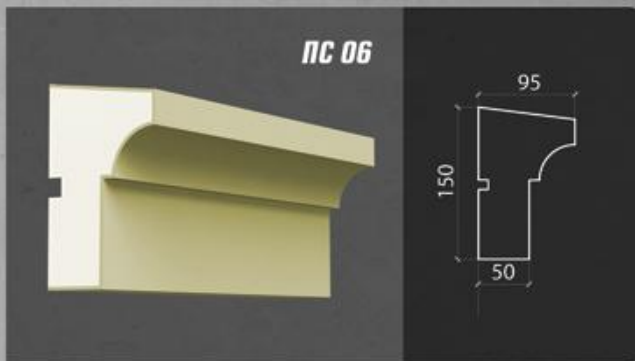
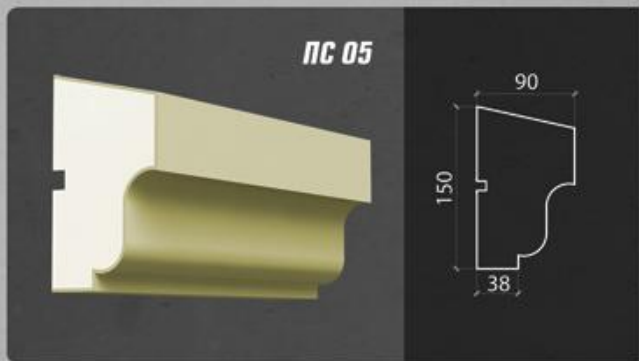
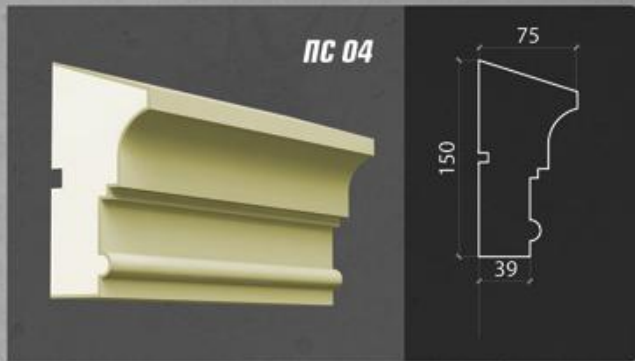
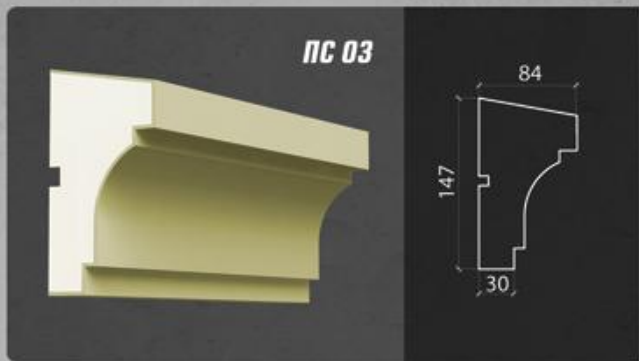
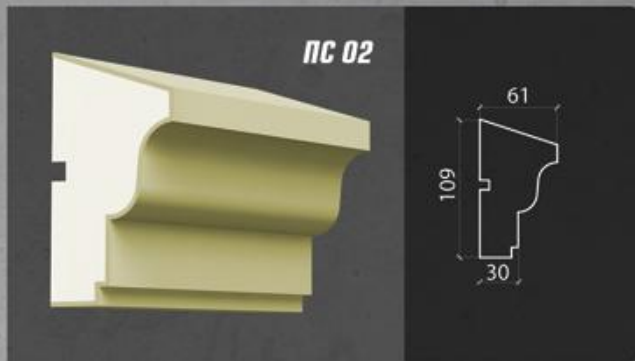
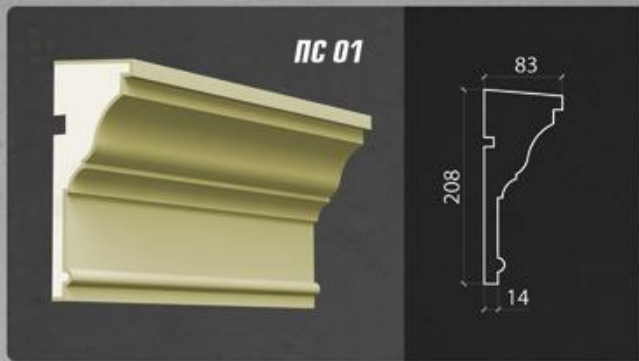

МОДУЛНИ



**ПС 09**



**ПС 10**



**ПС 11**

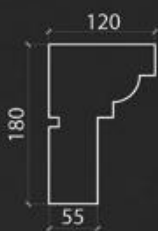

**ПС 12**



**ПС 13**

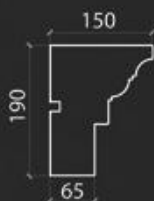

**ПС 14**

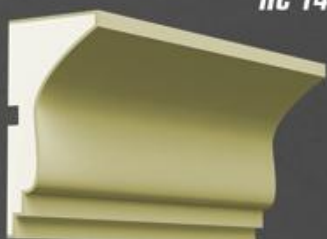

**МОЛДИНГИ**

**ПП 29**

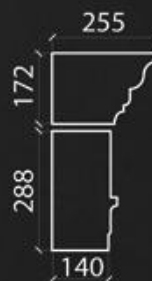

**ПС 26**





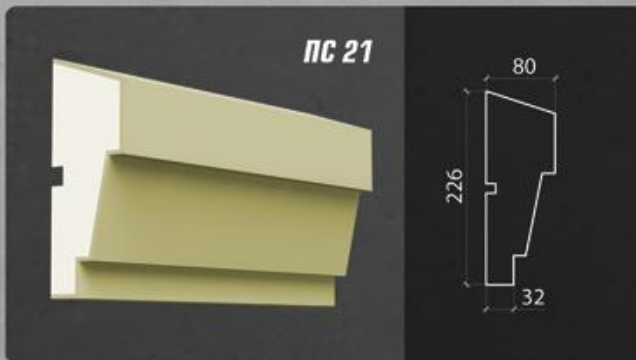
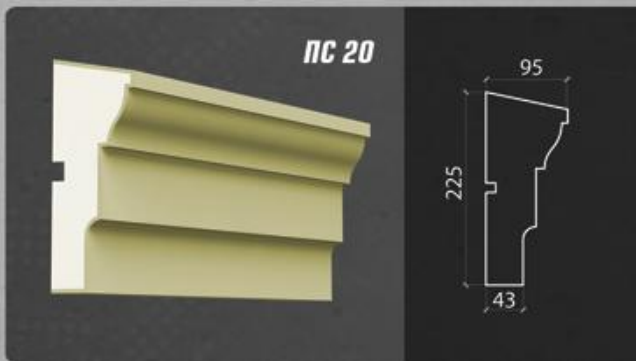
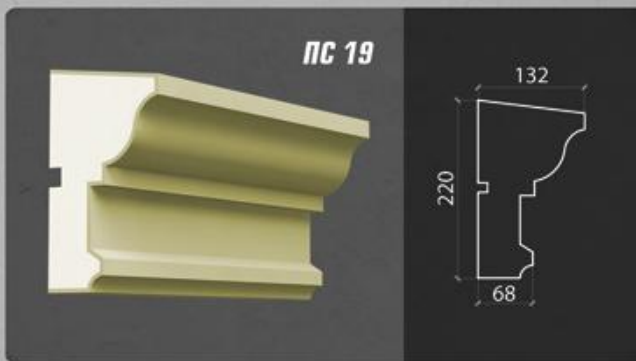
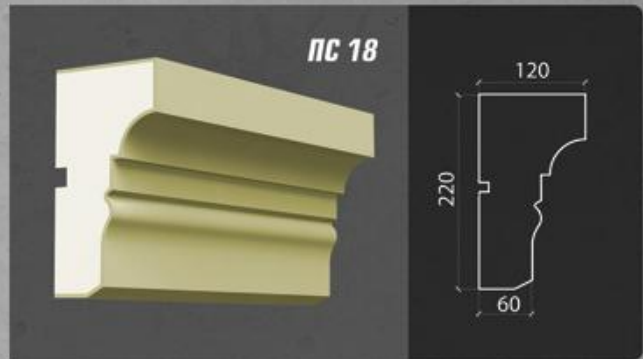
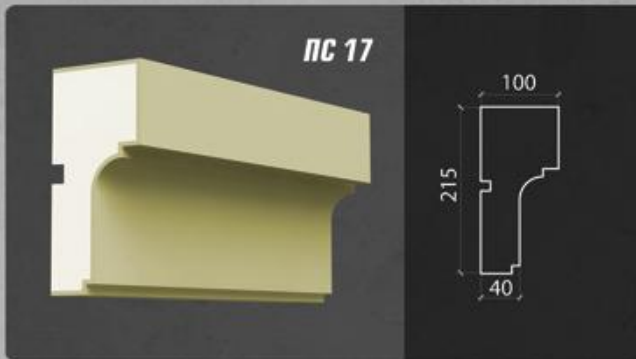
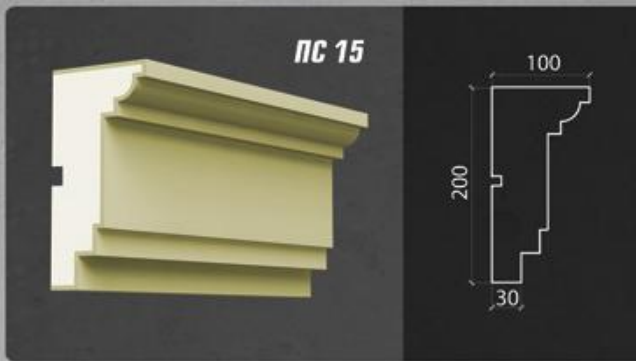

**МОЛДИНГИ**



**ПС 22**

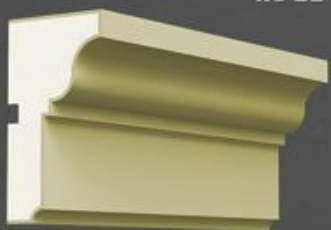

**ПС 23**

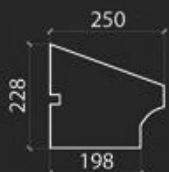

**ПС 24**



**ПС 25**

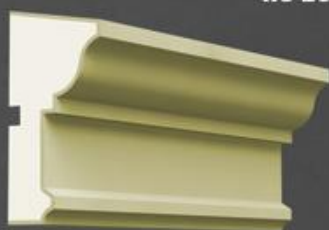

**ПС 26**

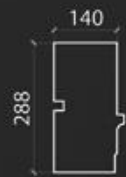

**ПС 27**



**ПС 28**



**ПС 29**



**МОЛДИНГИ**

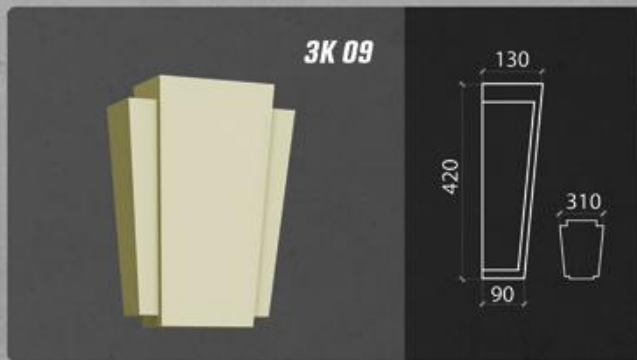
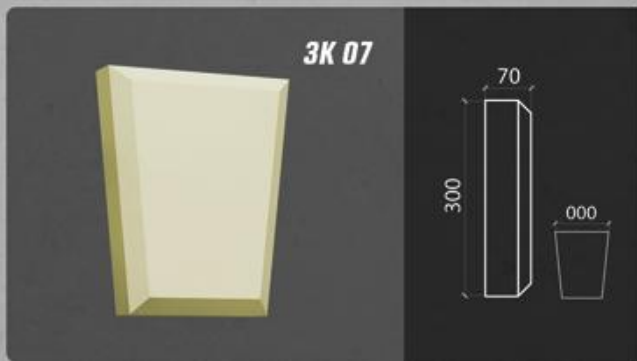
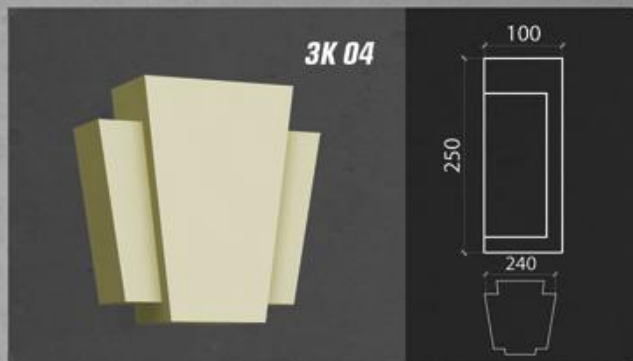

ЗАМКОВЫЕ КАМНИ

ПИЛЯСТРЫ

**ПЛ 01**

КП 02  
ПЛ 01  
БЗ 01

175  
70  
2000

**ПЛ 02**

КП 02  
ПЛ 02  
БЗ 01

175  
70  
2000

**КП 01**

КП 01  
БЗ 01

245  
108  
225  
230  
95

**БЗ 01**

БЗ 01

235  
80

**КП 02**

КП 02  
БЗ 02

245  
125  
235  
80  
110

**БЗ 02**

БЗ 02

235  
80

**КП 03**

КП 03  
БЗ 03

420  
225  
640  
270  
80

**БЗ 03**

БЗ 03

235  
80

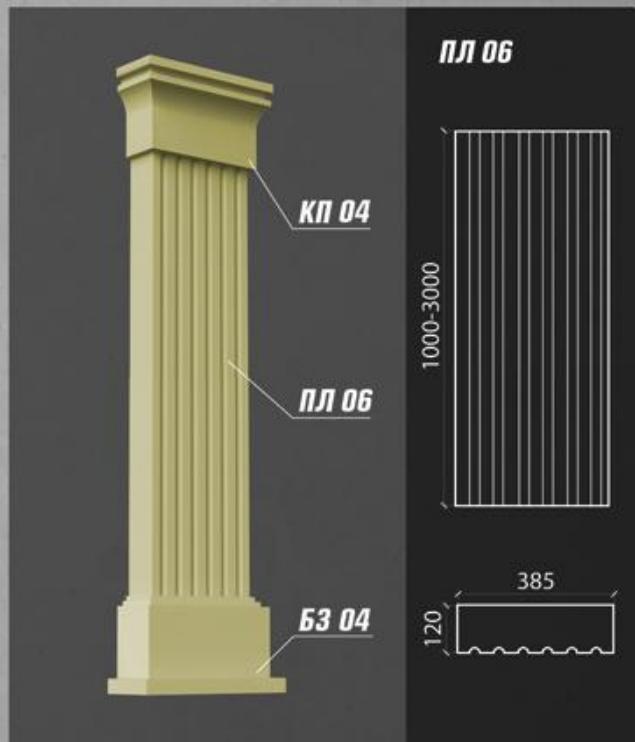
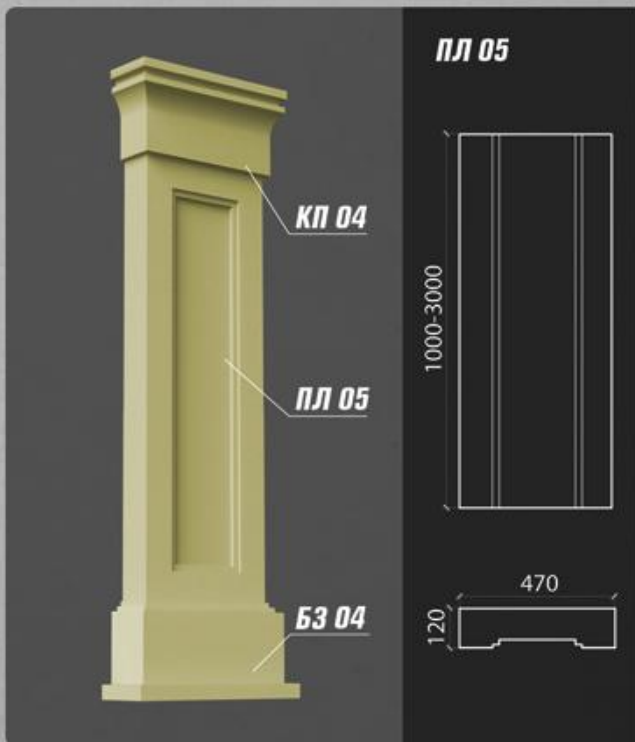
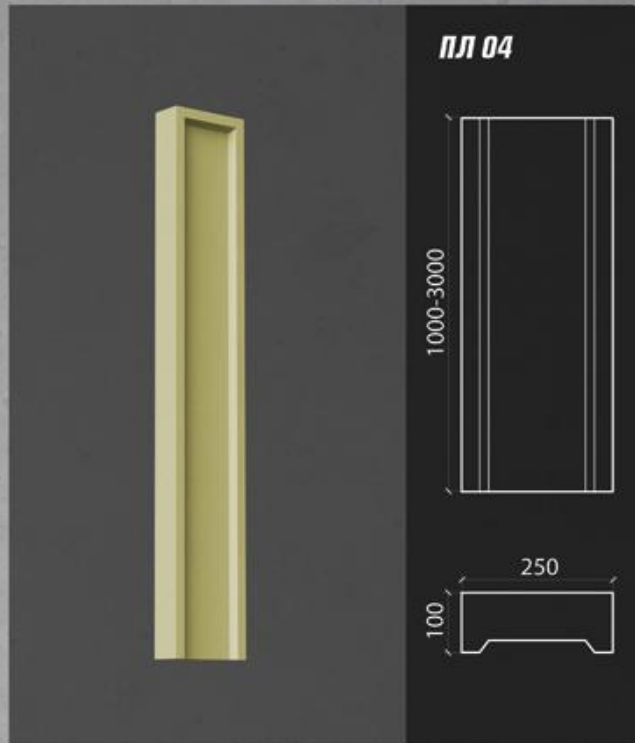
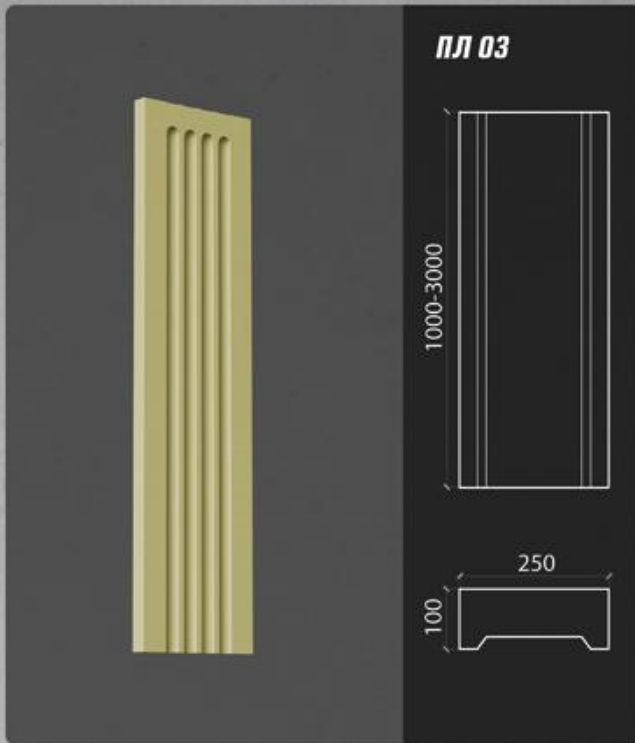

ПЛАСТЫРЫ



КОЛОННЫ

**КЛ 01**

2000

$d = 200 \quad 300$

**КЛ 02**

2000

$d = 200 \quad 300$

**КП 05**

$\varnothing D$

$h$

$\varnothing C$

$D =$	286	420
$C =$	220	320
$h =$	90	130

**БЗ 05**

$\varnothing D$

$h$

$c$

$D =$	220	320
$c =$	350	515
$h =$	160	230

**КП 06**

$\varnothing D$

$h$

$\varnothing C$

$D =$	330	480
$C =$	220	320
$h =$	125	175

**БЗ 06**

$\varnothing D$

$h$

$c$

$D =$	220	320
$c =$	310	450
$h =$	130	190

**КП 07**

$\varnothing D$

$h$

$\varnothing C$

$D =$	250	365
$C =$	220	320
$h =$	70	93

**БЗ 07**

$\varnothing D$

$h$

$c$

$D =$	220	320
$c =$	290	420
$h =$	90	130

**КН 01**

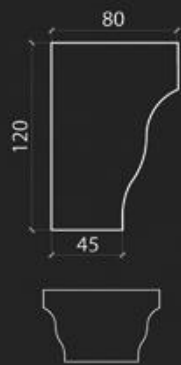
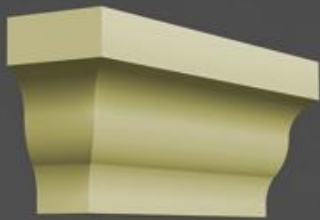

**КН 02**



**КН 03**

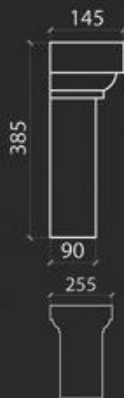

**КН 04**

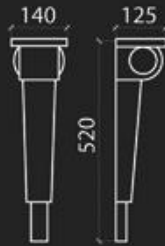

**ФЛ 01**



**ФЛ 02**



**ФЛ 03**



**ФЛ 04**



**КОНСОЛИ**

**ФИЛЁНКИ**



ОТК 01



h = 100 300

ОТК 02



h = 100 300

ОТК 03



h = 100 300

ОТК 04

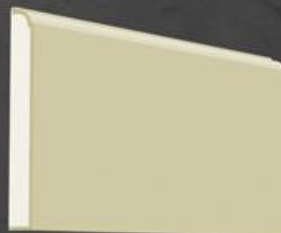

h = 100 300



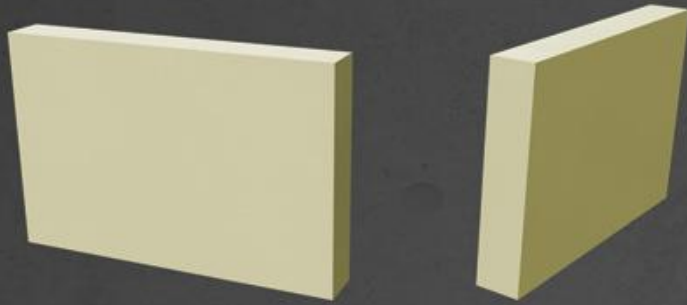

**PK 01**

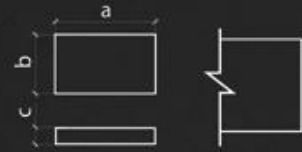

$a =$	200	250	300	350
	400	500	600	700
$b =$	200	250	300	350
$c =$	30	40	50	

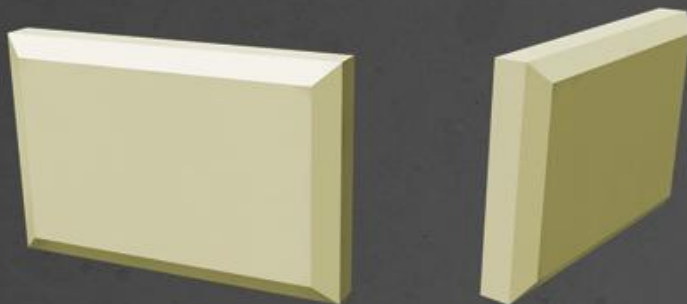

**PK 02**



$a =$	200	250	300	350
	400	500	600	700
$b =$	200	250	300	350
$c =$	30	40	50	

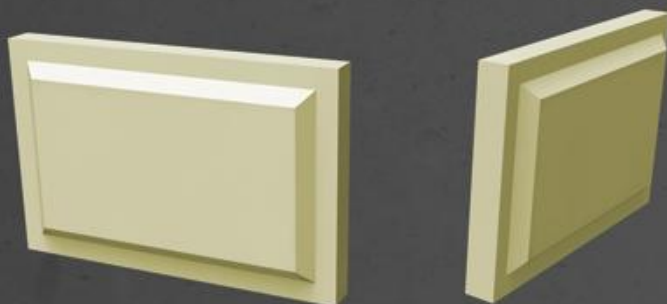

**PK 03**

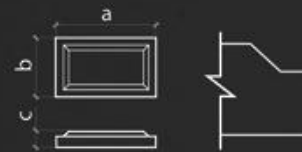

$a =$	200	250	300	350
	400	500	600	700
$b =$	200	250	300	350
$c =$	30	40	50	

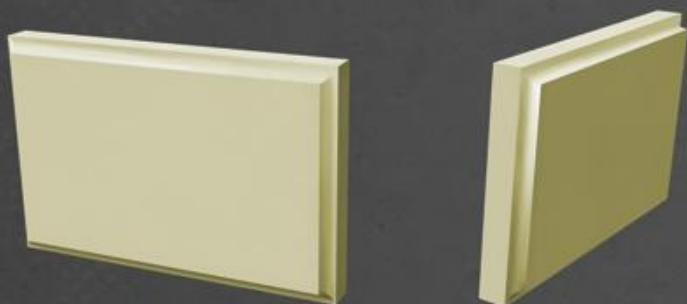

**PK 04**



$a =$	200	250	300	350
	400	500	600	700
$b =$	200	250	300	350
$c =$	30	40	50	

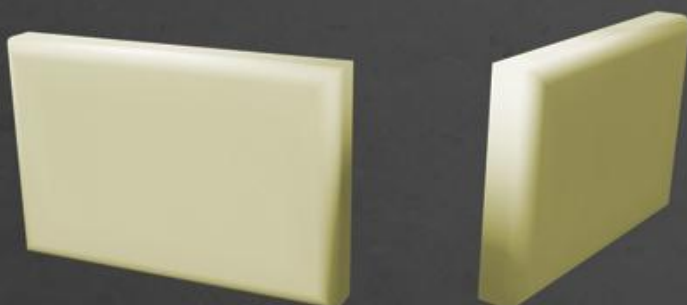

**PK 05**



$a =$	200	250	300	350
	400	500	600	700
$b =$	200	250	300	350
$c =$	30	40	50	

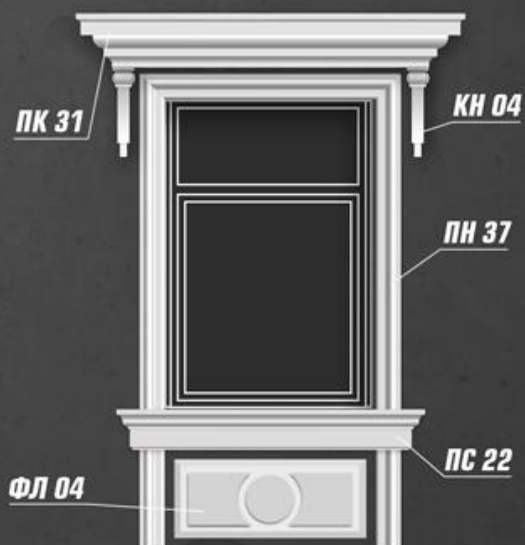
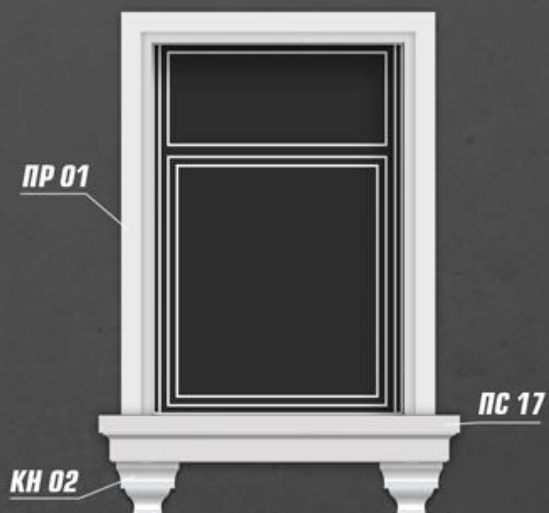
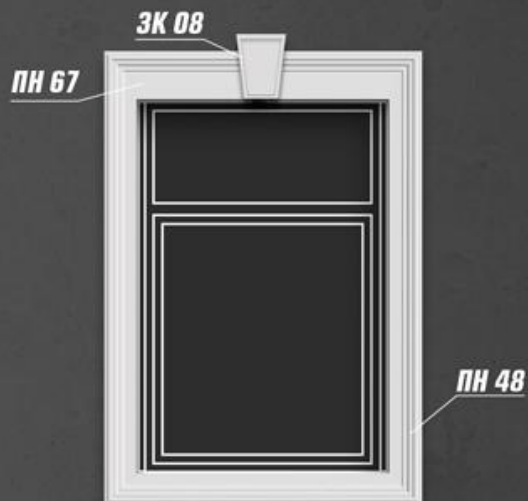
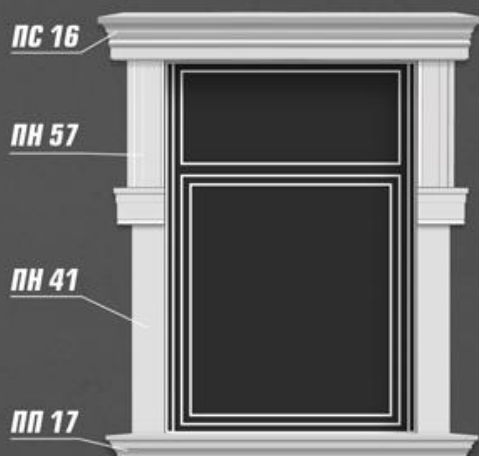
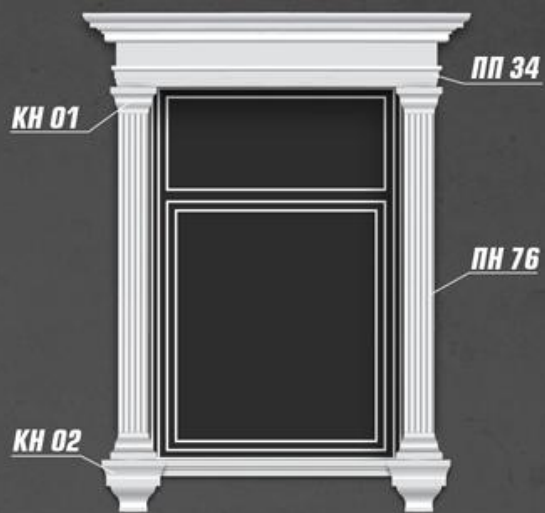

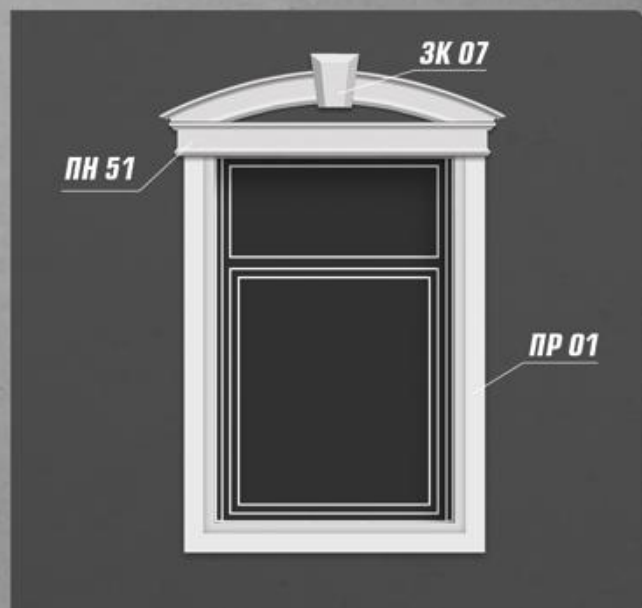
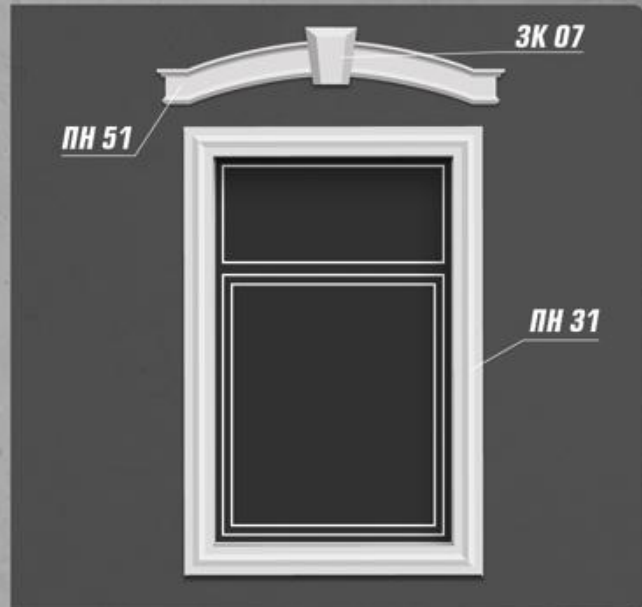

РЕШЕНИЕ

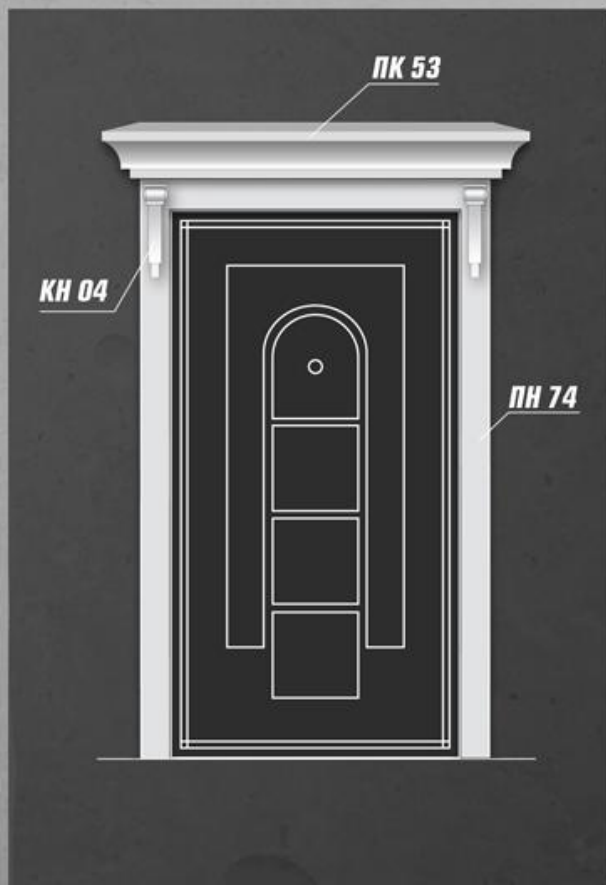
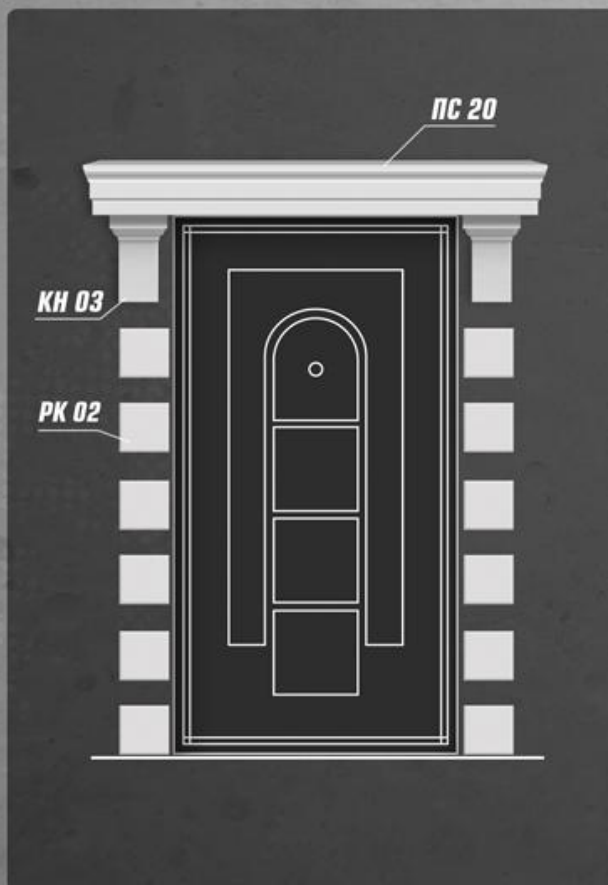
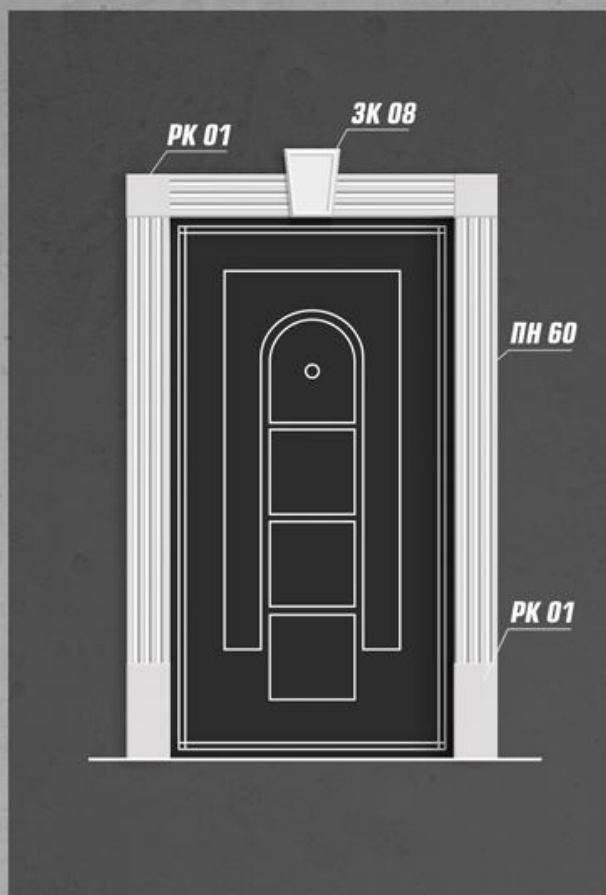
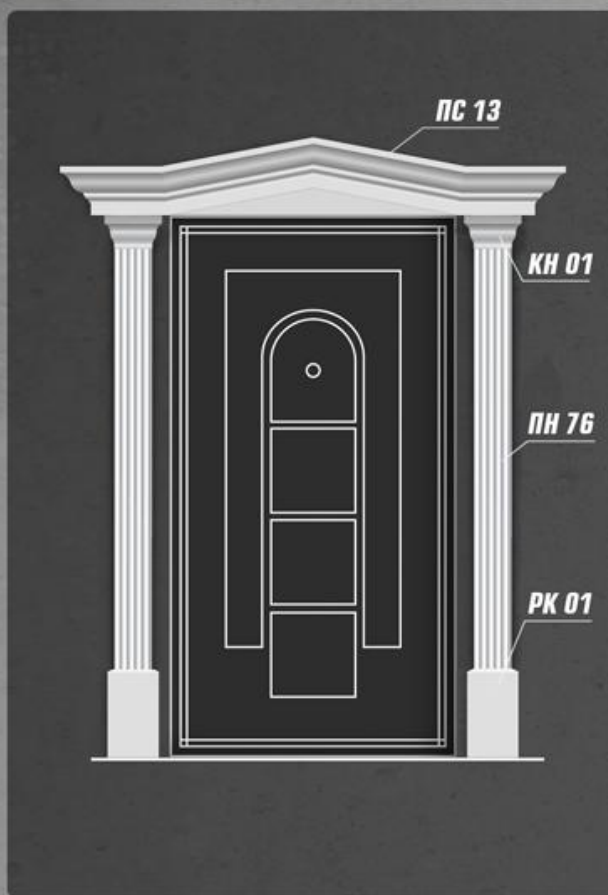

**БЛ 01**

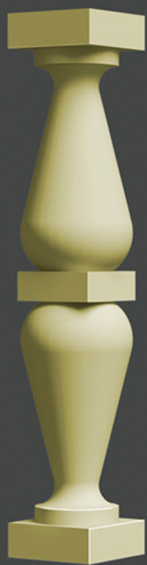

**БЛ 02**



**БЛ 03**



**КС 01**

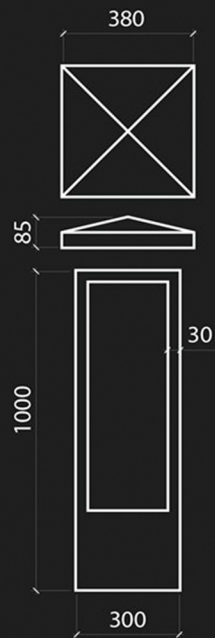

**СБ 01**

**КП 08**

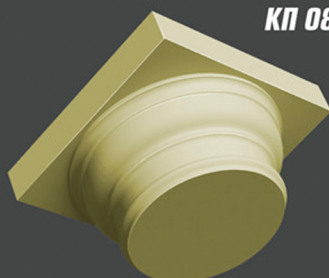

**БЗ 08**

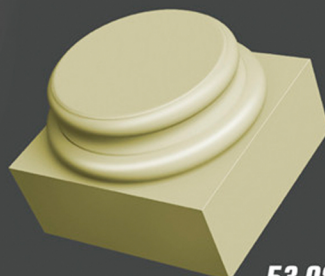

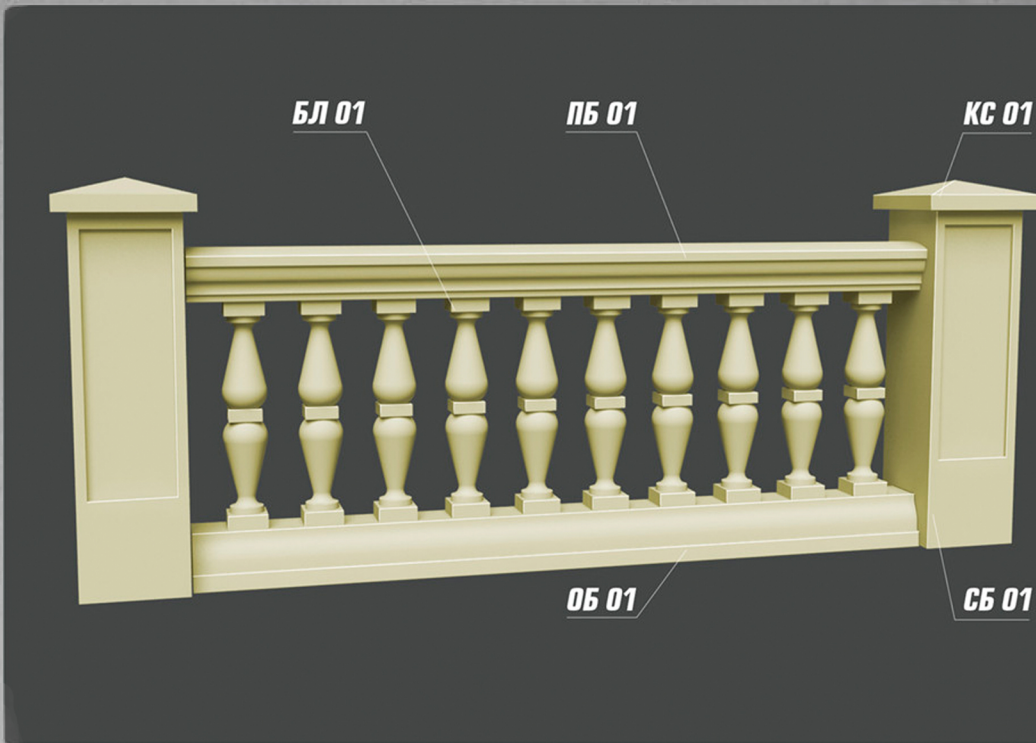

**ПБ 01**

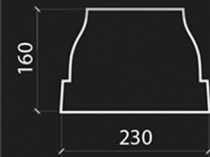
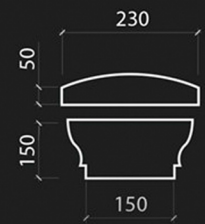

**ОБ 01**

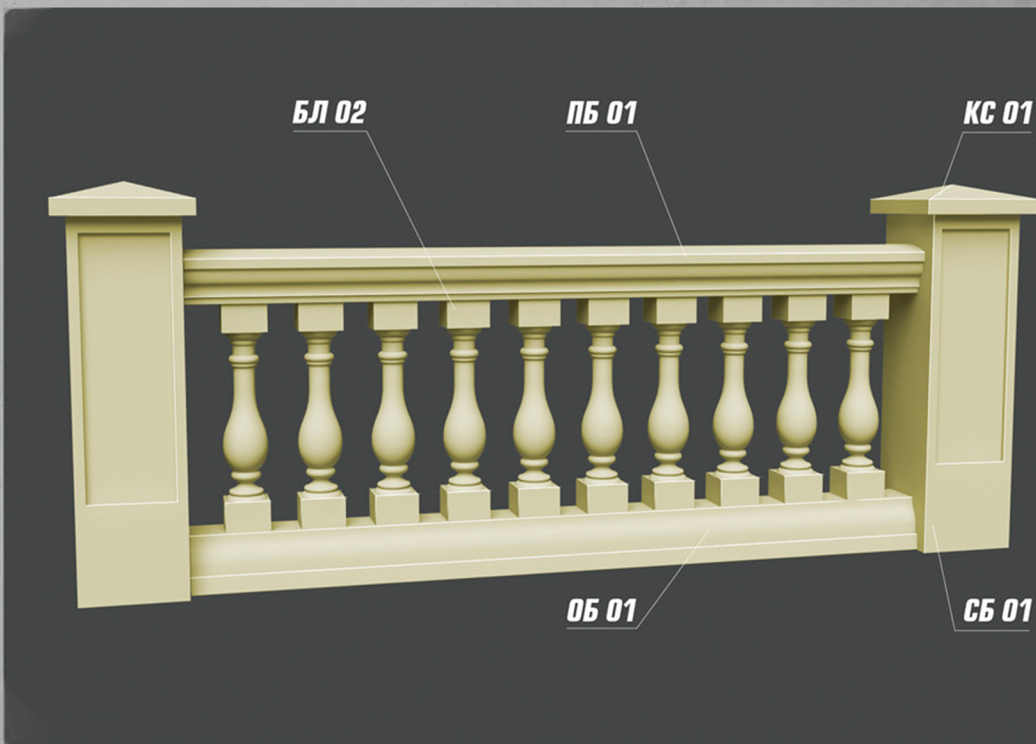

**ПБ 01**

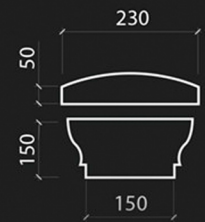

**ОБ 01**

БАЛЮСТРАДА

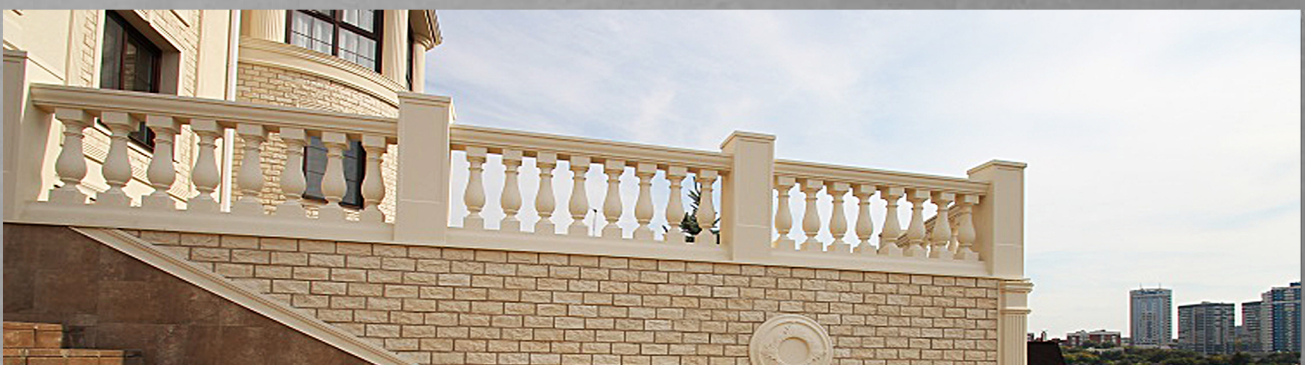

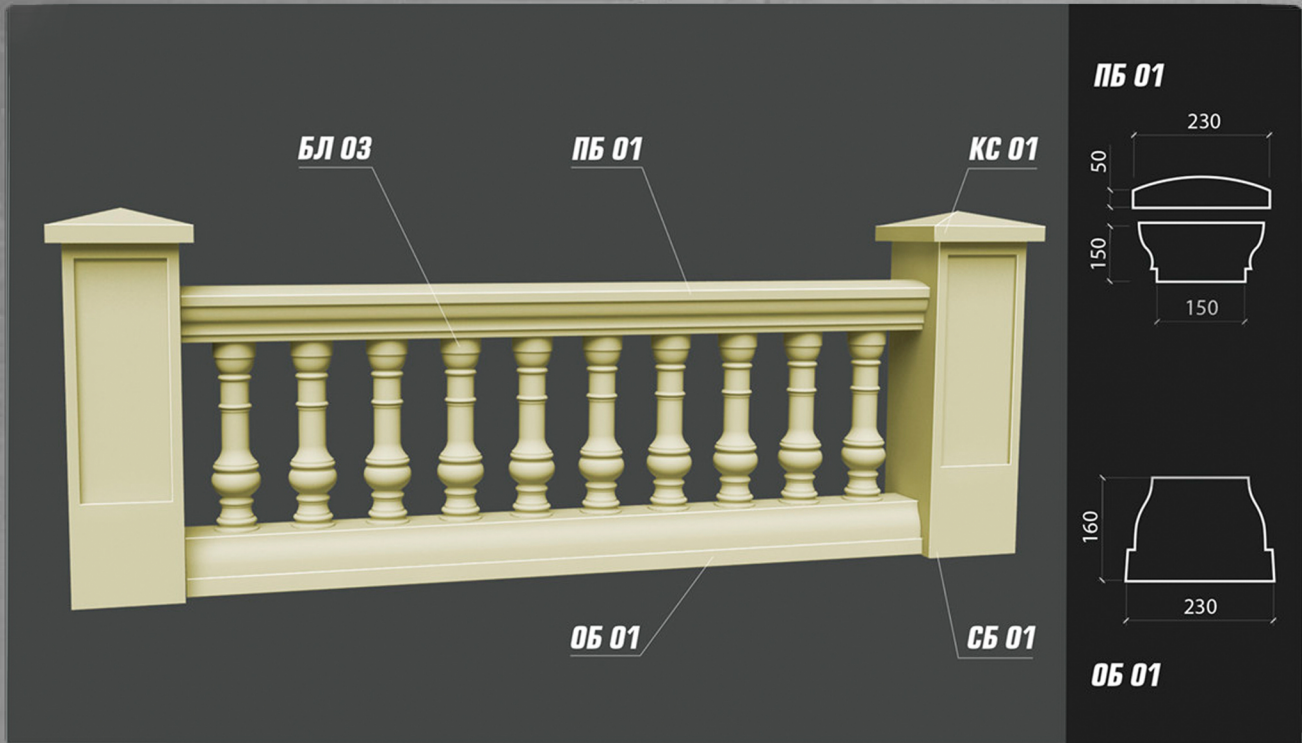

БАЛЮСТРАДА

